

Prospectus 2016-2017

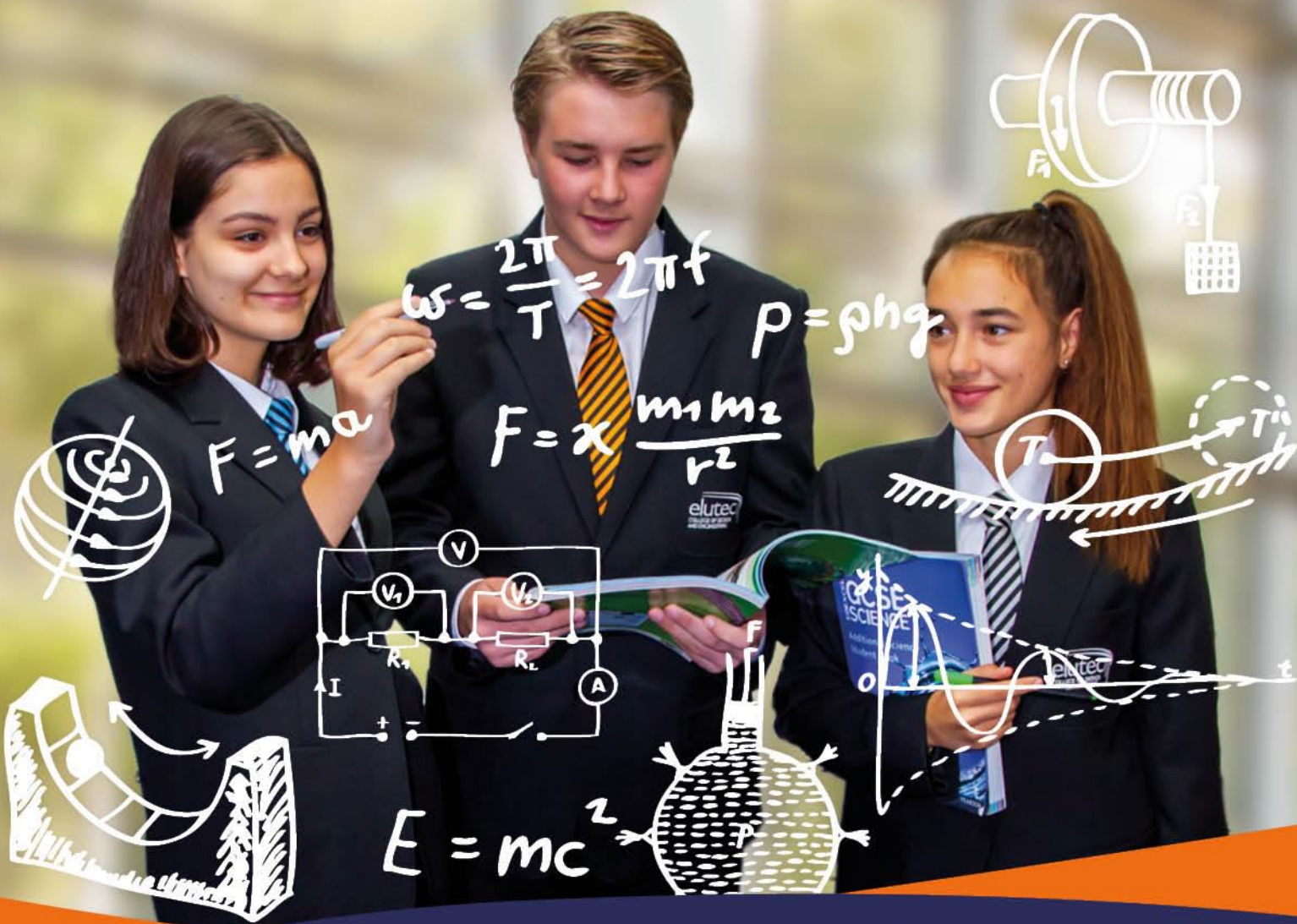

www.elutec.co.uk

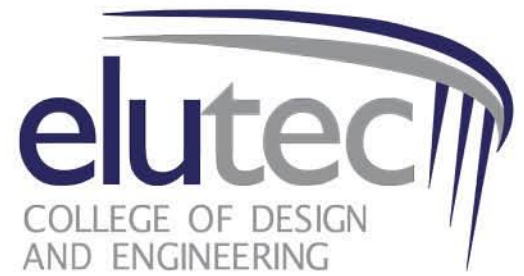

Engineering. Education. Employment.

Contents

About us	4
Vision	6
Values	7
Key Stage 4	8
Extension activities	9
Sixth Form	10
Progression routes	11
Industry partnership	12
Students	14
Campus	16
Admission	18



I have great pleasure in introducing you to our 2016/17 prospectus. Elutec offers an incredibly exciting educational experience to young people aged 14-19 in east London and Essex who are interested in engineering, design and technology, sciences and maths. Our first students were extremely enthusiastic about joining Elutec and worked with us before we opened on the uniform design, the structure of our pastoral system and ideas for creating international links.

At Elutec our focus is on educating and preparing young people for work. Our curriculum is designed in collaboration with industrial partners and sponsors and this enables us to deliver the skills and qualifications that are required by industry and top universities.

Located on a working campus, londoneast – uk, in Dagenham, our students quickly mature because they are interacting with employers on a regular basis thus developing employability as well as academic and technical skills.

We are very privileged at Elutec to have four world-class sponsors. Ford Motor Company, the multinational and innovative car manufacturer, University College London (UCL) one of the leading universities in the world for science and engineering, CEME (The Centre for Engineering and Manufacturing Excellence), and Procat who have wide and successful experience of delivering technical education in Essex. All of our sponsors have worked tirelessly with us to realise our dream of creating an innovative, inspirational school which will support, stretch and challenge young people to be the very best they can be.

Please read on to find out more about our offer and come along to one of our events where you can meet our staff, sponsors and partners.

A handwritten signature in blue ink that reads "Ruth Umerah".

Mrs Ruth Umerah

Principal

About us

A specialist engineering and design school for 14-19 year olds.



Elutec is a University Technical College focused on providing both an academic and a technical education that meets the needs of modern employers for 14-19 year olds. Offering engineering courses and work-related learning, combined with broader academic studies in English, mathematics and sciences, Elutec will prepare students for exciting careers.

Elutec's specialisms are engineering and design. We have high aspirations for all our students and believe that we can develop young people who will have the capability to influence UK and international industry in the future.

Elutec operates more like a business than a school and students mix with our partners from industry and work on industry – standard machinery. This helps to prepare them for the workplace.

Our curriculum is delivered in conjunction with industrial partners like Ford, BP, National Grid and our university partner UCL (University College London), to ensure we offer the best possible progression routes into employment, apprenticeships and further/higher education. As challenge partners, they work closely with us to develop learning that takes place in a real world context. Students will undertake a high number of visits to our partners' own premises and our partners' employees visit Elutec to deliver sessions too.

Elutec admits 150 students into year 10 and 150 into year 12. We are taking applications now for both year groups for full time courses starting in September 2016.



"Great feats of British engineering have helped to shape the modern world in which we live, and for London to continue to grow, we need to support the young people who will design and construct the huge engineering projects that will define our nation.

The new college will be instrumental in ushering in the next generation of great British engineers"

Mayor of London
Boris Johnson

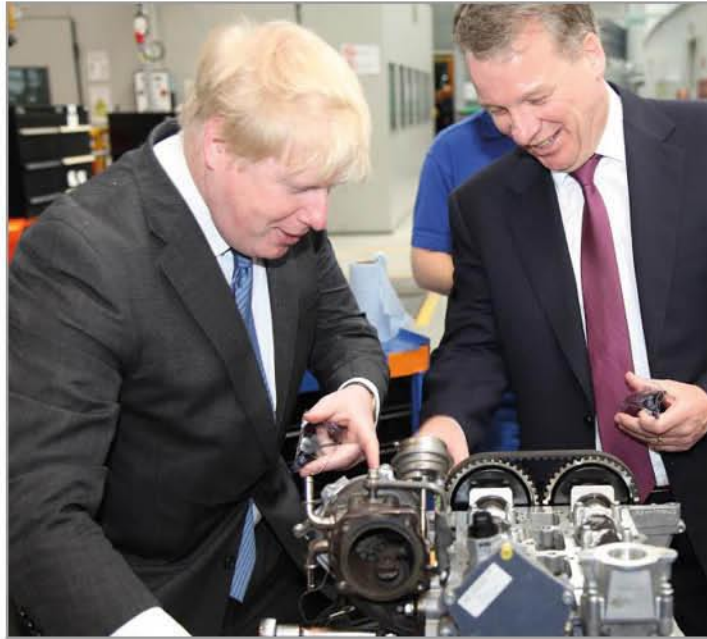

"Work placements mean that these students will be 'work ready' when their courses finish, in addition to possessing relevant qualifications to pursue their careers. Elutec has a bright future and we look forward to accelerating its success"

Ford of Britain Chairman and Managing Director
Mark Ovenden

"A UTC in east London will educate engineers and technicians who can realise the world-changing technologies that we want to deliver. Together we are able to deliver innovation and growth"

**Dean of the Faculty of Engineering Sciences,
University College London**
Prof. Anthony Finkelstein



Vision

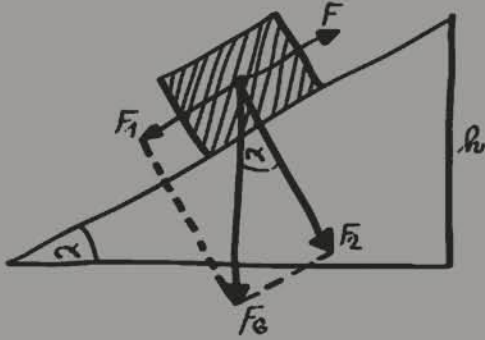

Our purpose is to provide young people in east London and Essex an opportunity to become the next generation of talented engineers and designers through a positive education experience which equips them with the skills, knowledge and personal qualities they need to have a successful career.



Our passion is to provide our students, staff and employer partners with a stimulating environment in which to learn, to educate and to connect.

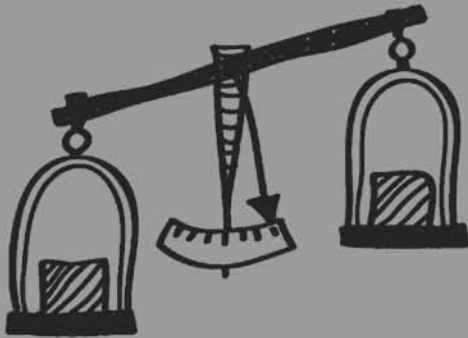

Our dream is that our students develop a strong sense of self-belief, and that they are happy and successful.



Our goal is to be the first choice for students, staff and employers with an interest in engineering, design, manufacturing and technology because of our partnerships, our results and our reputation.

Values

Positive attitude - at Elutec we embrace enthusiasm, encourage and expect a can-do attitude. We strive to employ optimistic staff with a positive outlook who constantly nurture and develop a positive attitude in students, colleagues and partners of Elutec.



A sense of urgency - at Elutec we believe that every day counts and we instil a desire to use that day well to achieve our goals and ambitions. We will strive to develop this quality in our students in their approach to life. We recognise that at Elutec we have our students for a year and a half before the real exam countdown begins. We will always strive to identify exactly where our students will benefit most before they arrive and will make plans to meet their individual needs from day one.



Innovation - at Elutec we encourage and celebrate positive new ideas and suggestions at every opportunity. We want our staff to be brave enough to be innovative in the curriculum and its delivery. We will encourage our students to be creative and to think independently and have the confidence to think differently.



Taking responsibility - at Elutec we will develop a sense of accountability for our own decisions. In our staff and our students we will encourage ambition and constant improvement. We will support measured risk-taking and expect and coach individuals to accept that the outcomes of their actions are their responsibility.

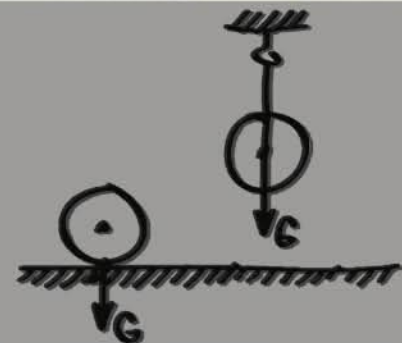

Curriculum

Key Stage 4

At the centre of the curriculum will be engineering and design.

Students in years 10 and 11 will complete a number of projects designed collaboratively between Elutec's industrial partners and the awarding body. In each project students will work in teams to solve real problems faced by industry. They will be supported through this challenging work by the partners and the Elutec teaching team and will present their findings to senior executives from the partner industries. The work that each individual student produces will meet the criteria for up to 4 GCSE qualifications in engineering design, manufacture, practical electrics and mechanics, electronics and control systems.

Students will also study core GCSEs in English language, English literature, maths, physics, chemistry, biology, ICT or computer studies. All students will follow a course in modern foreign languages and some will study for GCSE German.

What is unique about the curriculum at Elutec is that the core curriculum will not be taught in isolation; this means that every lesson that students attend will be linked to the engineering project they are completing. This could mean that whilst students are working on an engineering project designing and making pistons and fuel pumps for an engine and investigating what the best materials for those components are, they are also studying materials in chemistry, investigating the properties of various metals to help them to make an informed choice in their engineering project. This is just one example. The curriculum will be integrated in every core subject and the schemes of work designed around the engineering challenges.

By learning in this integrated way, Elutec students will never ask why they are studying a topic. By understanding its relevance, Elutec's students will be better motivated, better informed and better prepared for academic success across the curriculum.





In addition to the academic curriculum students will undertake a course in performing engineering operations (PEO) which develops mechanical engineering skills with a wide range of equipment from hand tools through to lathes and turret mills. They also take part in two hours of physical education a week, careers education and PSHE (personal, social and health education). Students will also undertake a week of work experience each year which will further develop their employment skills.

Extension activities

All students in all year groups will undertake extension activities one afternoon a week. This is a great opportunity for them to mix with their peers from other year groups and work on projects or partake in sports or hobbies, some of which they may never have had the opportunity to try before.



Elutec is a unique school for the east London and Essex area. We work in partnership with UCL and leading employers such as Ford to ensure that we deliver a curriculum for the 21st century that prepares young people for the workplace whether at 16, 18 or 21 by:

1. Providing a curriculum that teaches the skills that industry had identified as in short supply.
2. Providing all students with their own laptop.
3. Operating from 8.30 am until 5.00pm to get students used to the hours of work in industry.
4. Providing compulsory extracurricular activities to teach leadership and teamworking.

Sixth Form

Most students in the sixth form will follow a level 3 programme where they will take 4 AS levels (or equivalents) in year 12 and then continue with 3 of them to A2 (or equivalent) in year 13. We may also offer a level 2 programme for students who need to improve their GCSE (or equivalent) qualifications.

Level 3

Students may choose to study for an engineering qualification which is worth 2 A levels. It will be taught around engineering challenges and Elutec's partners will be involved in developing and delivering the curriculum. This enables the students to work directly with potential employers, all of whom will be looking for their next recruits. From September 2016 we are also offering a level 3 art and design programme which will be of particular interest to those wishing to pursue careers in architecture, graphics or fashion design.

The A level subjects on offer will be maths, physics, chemistry, biology, product design, ICT or computing science and English. Additional subjects may be available if there is sufficient demand.

All students in the sixth form will receive careers education and guidance to support them in choosing the correct pathway for the future, be it higher education, an advanced apprenticeship or other employment. In addition, students will undertake physical education, enterprise education and PSHE.

Students will also undertake a week of work experience each year and, if appropriate, will be encouraged to pursue further work experience as part of their regular curriculum.



Progression routes

Age 14



Age 15

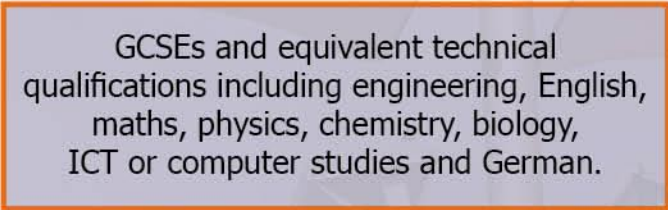

Age 16



Age 17

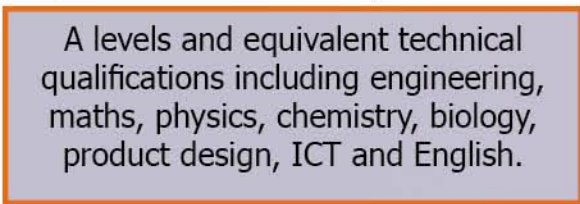

Age 18+



Industry partnership

Links to real world people, products and process.

What makes the Elutec experience unique is the partnerships we have with industry and the way our curriculum is driven by local and international employers. All students will work closely with business managers and engineers throughout the year either on the Elutec campus or at their own facilities. We believe it is important for our students to access the world of work as part of their studies in two ways.

1. Challenge Partners. These organisations work closely with the team at Elutec to integrate real products and technical design programmes into the curriculum. Students visit the employer to see these products in action and discuss technical issues with their engineers and managers. Back at Elutec, students will research the products or processes, work on real products and then solve a design and build challenge set by the company. These challenges are developed the awarding body, and form the final module assessment tasks which deliver engaging and up to date real world learning.

2. Enterprise Partners. We value the input from the organisations who work with us to provide opportunities for work experience, industry mentoring, work shadowing, award sponsorship, young enterprise, case studies, guest lectures, seminars, training, scenario role play, interview preparation, apprenticeship placement, financial and product or equipment donation. They are key to a broad engagement with industry for our students.



Our challenge partners include:



Vehicle sub assembly design,
development and testing



Power delivery systems



Component Maintenance
and failure prevention



Robotics and Engduino
development



Diamond milling
machine tooling



Electronic systems
and control



Maintenance systems &
racing kart development



Hydrogen Fuel
Cell technology



Imaging, earth
and space based



High Speed Sustainable
Manufacturing



Oils and lubricant
technologies

Students

Providing support for students and parents.

For some students, the move to a completely new school at this stage may seem daunting, however, the Elutec team will support families through the transition. The learning opportunity we offer is completely unique to the region in terms of being able to provide hands-on learning in engineering and design for 14-19 year olds, with local employer and university involvement.

In years 10 and 11, all students will be placed in a company group of around 50 students. Within each company, there will be a team of mentors who will support the pastoral, learning and technical needs of all the students. Each mentor will look after around 13 students and will be the first point of contact for parents. Parents will receive a report from their child's mentor once every 3 weeks outlining targets that have been agreed between the mentor and their mentee to help the mentee maintain or improve their progress.

A student's mentor will know them really well because the mentor will be supporting across the whole curriculum, supervising the students at lunchtime and regularly having one-to-one meetings to discuss and resolve any barriers to well-being and achievement at school.

Each company will be led by an engineering teacher, and they will work together to compete against other companies for rewards, success in sports, and the best records for attendance and academic progress. Students will have a real pride in their company and will show loyalty to the company staff and students.





The sixth form is led by our assistant principal and sixth formers are supported by a dedicated and experienced member of staff who can provide them with advice and guidance about their next steps.

All students will also be allocated a tutor who will meet with them weekly, both as part of the tutor group and individually. The tutor will be the first point of contact for parents and for the student's subject teachers. The sixth form team will be able to guide students through their sixth form years by supporting their learning, helping them to cope with the pressures of studying at this level, and providing them with information, advice and guidance in terms of their next steps in achieving their ambitions; whether that be through apprenticeship, other employment with training, or university.



Elutec is a non-selective school and caters for all students with a real passion for its curriculum along with an understanding of its challenges.

Students with special educational needs are well provided for with an experienced special needs manager leading a team of learning support mentors. Our focus at Elutec is for every student to achieve their full potential.

Campus

A world-class education campus.

Elutec is situated at the londoneast – uk business and technical park in Dagenham, east London. This new campus, formerly the site of the Sanofi Science Park, is currently being developed to house a range of businesses, all of whom will provide vital links to industry for Elutec.

The school has been designed to meet the needs of students and developed to support them through their time in education, providing industry standard facilities for engineering and product design which include:



- Fully equipped classrooms
- Industry standard workshops
- Rapid prototyping facilities
- A lecture theatre (CUBE)
- A learning resources centre
- A restaurant
- Mechatronics and process control facilities
- Fast IT networks with student WiFi access for their laptops
- Access to playing fields and sport facilities to the rear of the buildings.
- Sports hall



The campus has excellent public transport access via the tube, over ground trains and the bus. There is a free shuttle bus provided to and from Rainham Station for those who travel on the C2C line.

The Elutec campus is ideally located for all forms of transport:

By Train

The C2C line links with the District line at Upminster and Barking stations.

By Underground

Elutec is located a short walking distance from Dagenham East station on the District line.

By Bus

The 174 operates every 8 minutes from Harold Hill via Romford and drops off at the rear of Elutec. The 364 runs from High Road (Ilford) via Dagenham East and stops at Dagenham East station bus stop. The 103 bus operates every 9 minutes from Chase Cross Road (Romford) and stops at Dagenham East station via Rainham station. The 145 bus runs from Hainault Street (Ilford) via Dagenham and stops at Dagenham East station.

By Car

Elutec is accessed via the A112 (Rainham Road South) which connects to the A1306 and A13, which in turn provides access to Central London with plenty of parking for drop off and at the rear of Elutec next to the May and Baker Sports and Social club.

By Bike

Ample cycle racks are provided on the campus for students travelling by bicycle. The londoneast – uk campus is a perfect location for a University Technical College as it sits in the heart of industry, where a range of small, medium and large organisations manufacture and supply locally, nationally and internationally. Students at Elutec gain a real sense of the real world and develop a deep understand of the workplace.



Apply now

Year 10

In year 10 priority is given to applicants living in the boroughs of Barking and Dagenham, Havering, Newham, Redbridge, Tower Hamlets and Thurrock. Students from outside these areas will be allocated places providing we are not full.

Applications for year 10 should be made through the school admissions website in the borough where they live.

See below the website address:

London Borough of Barking and Dagenham

<http://www.lbbd.gov.uk/Education/Admissions/Pages/AdmissionstoSchools.aspx>

London Borough of Havering

<https://www.eadmissions.org.uk/eAdmissions/app>

London Borough of Newham

<https://www.eadmissions.org.uk/eAdmissions/app>

London Borough of Redbridge

http://www2.redbridge.gov.uk/cms/children_and_schools/school_support_information/applications_and_admissions/secondary_school_applications.aspx

London Borough of Tower Hamlets

www.towerhamlets.gov.uk/schooladmissions

Thurrock Council

<https://admissions.thurrock.gov.uk/Enrol/Website/>

Applications will be taken after the published closing date of 31st October 2015 although if we are full a waiting list system will apply.

Year 12

Students should apply direct to Elutec on the sixth form application form. Forms can be found on our website. The closing date for application into the sixth form is Monday 4th January 2016. Applications will be taken after the published closing date although priority will be given to those who applied before this date. Students will be invited in for a meeting with a member of the senior team after the closing date to discuss their applications.

Please contact the team at Elutec if you have any queries about the admission process.

Students choose Elutec because...



"I would like to thank all the people who supported me during my first year at school.

Elutec is like a family where everyone is welcome. The school is a safe, yet friendly environment where everyone has an opportunity to shine through and achieve their goals. I look forward to achieving even greater awards and potentially be the best I can possibly be. Thank you very much."

Year 11 student, Bell Company,
Steven Kakulu

...connections with large companies... a wide experience with the working world... knowledge in the world of product design.

...experience... knowledge... friendship... find out more about the big world of engineering...

Elutec specialises in the career I want to pursue later on in life. It looks like it has high standards and I would like to be a part of this sixth form. I feel Elutec will both guide and push me.

I want to be a part of the future. I want to be able to help in a way that I will be able to make a change in the world for the better!

Elutec will give me the best opportunity to succeed in the future. It is different from any other sixth form.



Sponsors and supporters



Challenge partners



Enterprise partners



Think big • Start small • Grow fast

www.elutec.co.uk



Elutec, Yew Tree Avenue,
Rainham Road South,
Dagenham East, RM10 7XS
0203 773 4670

